

LH/LH-W Series

Submersible High-Head/Extra High-Head Dewatering Pumps

OPERATION MANUAL

INTRODUCTION

Thank you for selecting the Tsurumi LH/LH-W Series submersible high-head/extra high-head dewatering pumps.

This operation manual explains the product operations and gives important precautions regarding its safe use. In order to use the product to maximum benefit, be sure to read the instructions thoroughly and follow them carefully.

To avoid accident, do not use the pump in any way other than as described in this operation manual. Note that the manufacturer cannot be responsible for accidents arising because the product was not used as prescribed. After reading this operation manual, keep it nearby as a reference in case questions arise during use.

When lending this product to another party, always be sure to include this operation manual as well.

If this operation manual should become lost or damaged, ask your nearest dealer or Tsurumi representative for another copy.

Every effort has been made to ensure the completeness and accuracy of this document. Please contact your nearest dealer or Tsurumi representative if you notice any possible error or omission.

The contents of this document may not be copied in whole or in part without the express permission of Tsurumi Manufacturing Co., Ltd.

CONTENTS

1. BE SURE TO READ FOR YOUR SAFETY	1
2. NAME OF PARTS	4
3. PRIOR TO OPERATION	5
4. INSTALLATION	6
5. ELECTRICAL WIRING	8
6. OPERATION.....	10
7. MAINTENANCE AND INSPECTION.....	12
8. DISASSEMBLY AND REASSEMBLY	15
9. TROUBLESHOOTING	19

1 BE SURE TO READ FOR YOUR SAFETY

Be sure to thoroughly read and understand the SAFETY PRECAUTIONS given in this section before using the equipment in order to operate the equipment correctly.

The precautionary measures described in this section are intended to prevent danger or damage to you or to others. The contents of this manual that could possibly be performed improperly are classified into two categories: **⚠ WARNING**, and **⚠ CAUTION**. The categories indicate the extent of possible damage or the urgency of the precaution. Note however, that what is included under **⚠ CAUTION** may at times lead to a more serious problem. In either case, the categories pertain to safety-related items, and as such, must be observed carefully.

- **⚠ WARNING** : Operating the equipment improperly by failing to observe this precaution may possibly lead to death or injury to humans.
- **⚠ CAUTION** : Operating the equipment improperly by failing to observe this precaution may possibly cause injury to humans and other physical damage.
- **NOTE** : Gives information that does not fall in the WARNING or CAUTION categories.
- **Explanation of Symbols:**



The \triangle mark indicates a WARNING or CAUTION item. The symbol inside the mark describes the precaution in more detail ("electrical shock", in the case of the example on the left).



The \circ mark indicates a prohibited action. The symbol inside the mark, or a notation in the vicinity of the mark describes the precaution in more detail ("disassembly prohibited", in the case of the example on the left).



The \bullet mark indicates an action that must be taken, or instructs how to perform a task. The symbol inside the mark describes the precaution in more detail ("provide ground work", in the case of the example on the left).

PRECAUTIONS TO THE PRODUCT SPECIFICATIONS

⚠ CAUTION



















Do not operate the product under any conditions other than those for which it is specified. **Failure to observe the precaution can lead to electrical leakage, electrical shock, fire, or other problems.**

















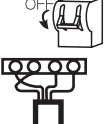





PRECAUTIONS DURING TRANSPORT AND INSTALLATION





⚠ WARNING

	<ul style="list-style-type: none"> • When transporting the product, pay close attention to its center of gravity and mass. Use an appropriate lifting equipment to lift the unit. Improper lifting may result in the product damage, injury, or death. 		<ul style="list-style-type: none"> • Install the product properly in accordance with this operation manual. Improper installation may result in electrical leakage, electrical shock, fire, or injury.
	<ul style="list-style-type: none"> • Electrical wiring should be performed in accordance with all applicable regulations in your country. Absolutely provide a dedicated earth leakage circuit breaker and a thermal overload relay suitable for the product (available on the market). Imperfect wiring or improper protective equipment can lead to electrical leakage, fire, or explosion in the worst case. 		<ul style="list-style-type: none"> • Provide a secure grounding dedicated for the product. Never fail to provide an earth leakage circuit breaker and a thermal overload relay in your starter or control panel (Both available on the market). If an electrical leakage occurs by due to a product failure, it may cause electrical shock.











 CAUTION	
 <ul style="list-style-type: none"> Provide a secure ground. Do not connect the grounding wire to a gas pipe, water pipe, lightning rod, or telephone ground line. Improper grounding may lead to electrical shock. 	 <ul style="list-style-type: none"> Install the discharge piping securely so that no water leakage may occur. Failure to do so may result in damage to nearby walls, floors, and other equipment. 
 <ul style="list-style-type: none"> Do not scratch, fold, twist, make alterations, or bundle the cable, or use it as a lifting device. The cable may be damaged, which may cause electrical leakage, short-circuit, electrical shock, or fire. 	 <ul style="list-style-type: none"> Do not use the cabtyre cable if it is found to be damaged. Connect the cabtyre cable securely to the terminals. Failure to observe this can lead to electrical shock, short-circuit, or fire. 
 <ul style="list-style-type: none"> When transporting or installing the pump, attach a wire rope or chain firmly to the eyebolt. Do not under any circumstances install or transport the pump by suspending it from the cabtyre cable. The cable may be damaged, which may cause electrical leakage, electrical shock, or fire. 	 <ul style="list-style-type: none"> This product is neither dust-proof nor explosion-proof. Do not use it at a dusty place or at a place where corrosive, toxic or explosive gas presents or may be generated. Use in such places could cause fire or explosion. 
 <ul style="list-style-type: none"> Let the unit suck minimum amount of sand or mud. When the pump is to be installed on a soft foundation, mount it on a concrete block or the like to prevent it from being submerged in sand. Damage resulting from abrasion may bring about electrical leakage or electrical shock. 	 <ul style="list-style-type: none"> If a hose is used for the discharge line, take a measure to prevent the hose from shaking. If the hose shakes, you may be wet or injured. 

PRECAUTIONS DURING TEST OPERATION AND OPERATION



 WARNING	
 <ul style="list-style-type: none"> Never start the pump if somebody is present in the pump sump. If an electrical leakage occurs, it can cause electrical shock. 	 <ul style="list-style-type: none"> When inspecting the pump, be sure to turn off the power supply (earth leakage circuit breaker, etc.) so that the pump may not start accidentally. Failure to do so may lead to a serious accident. 
 <ul style="list-style-type: none"> Never start the pump while it is suspended, as the unit may jerk and lead to injury. 	
 CAUTION	
 <ul style="list-style-type: none"> Do not operate the product under any voltage other than described on the nameplate with the voltage variation limit within $\pm 10\%$. If it is operated with a generator, it is strongly suggested not to operate other equipment with the same generator. Failure to observe this caution may cause malfunction and breakdown of the product, which may lead to electrical leakage or electrical shock. 	 <ul style="list-style-type: none"> Check that the motor rotates in the correct direction of rotation. Operating in the wrong direction may damage the pump, which may cause electrical leakage or electrical shock. 
 <ul style="list-style-type: none"> Do not run the product dry or operate it with its maximum head, as doing so will damage the product, which may lead to electrical leakage or electrical shock. 	 <ul style="list-style-type: none"> Do not use the product in a liquid other than water. Use in oil, salt water or organic solvents will damage it, which may lead to electrical leakage or electrical shock. 
 <ul style="list-style-type: none"> Do not use the product in hot or warm liquid over 40°C, as doing so will damage the product, which may lead to electrical leakage or electrical shock. 	 <ul style="list-style-type: none"> Do not touch the product with bare hands during or after the operation, as the product may become very hot during operation. Failure to observe this caution may lead to be burned. 

 CAUTION	
 <ul style="list-style-type: none"> Never insert a finger or any other object into the pump inlet holes. Failure to observe this caution may lead to injury. 	 <ul style="list-style-type: none"> When the product will not be used for an extended period, be sure to turn off the power supply (earth leakage circuit breaker, etc.). Deterioration of the insulation may lead to electrical leakage, electrical shock, or fire. 



PRECAUTIONS DURING MAINTENANCE AND INSPECTION

 WARNING	
 <ul style="list-style-type: none"> Absolutely turn off the power supply and make sure that the impeller has stopped completely before starting maintenance or inspection. Failure to observe this caution may lead to death or major accident. 	 <ul style="list-style-type: none"> Do not disassemble or repair any parts other than those designated in the operation manual. If repairs are necessary in any other than the designated parts, consult with the dealer where it was purchased or Tsurumi representative. Improper repairs can result in electrical leakage, electrical shock, or fire. 
 <ul style="list-style-type: none"> In case any abnormality (excessive vibration, unusual noise or odor) is found in the operation, turn the power off immediately and consult with the dealer where it was purchased or Tsurumi representative. Continuing to operate the product under abnormal conditions may result in electrical shock or fire. 	
 CAUTION	
 <ul style="list-style-type: none"> After reassembly, always perform a test operation before resuming use of the product. Improper assembly can result in electrical leakage, electrical shock, or fire. 	

PRECAUTION TO POWER OUTAGE

 WARNING	
 <ul style="list-style-type: none"> In case of power outage, turn off the power supply. The product will resume operation when the power is restored, which presents serious danger to people in the vicinity. 	

OTHER PRECAUTION

 CAUTION	
 <ul style="list-style-type: none"> Never use the product for potable water. It may present a danger to human health. 	

2 NAME OF PARTS

Model LH

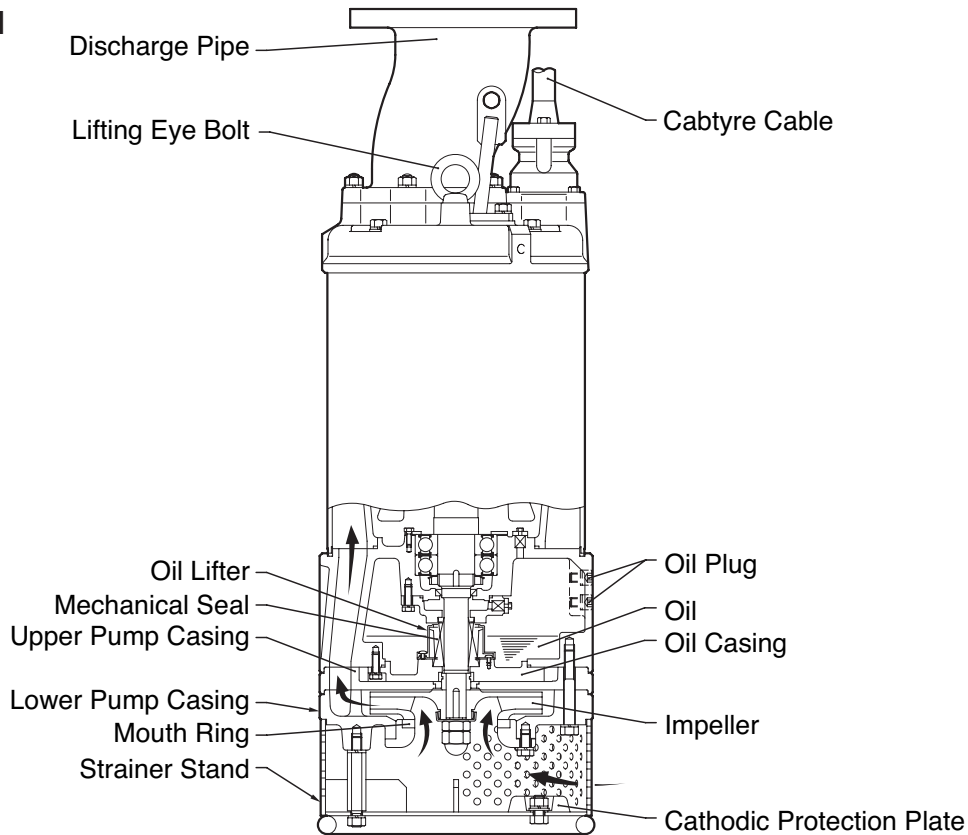

Note: *The above diagram is typical of the LH Series, but some models may vary slightly in appearance or internal structure.*

Model LH-W

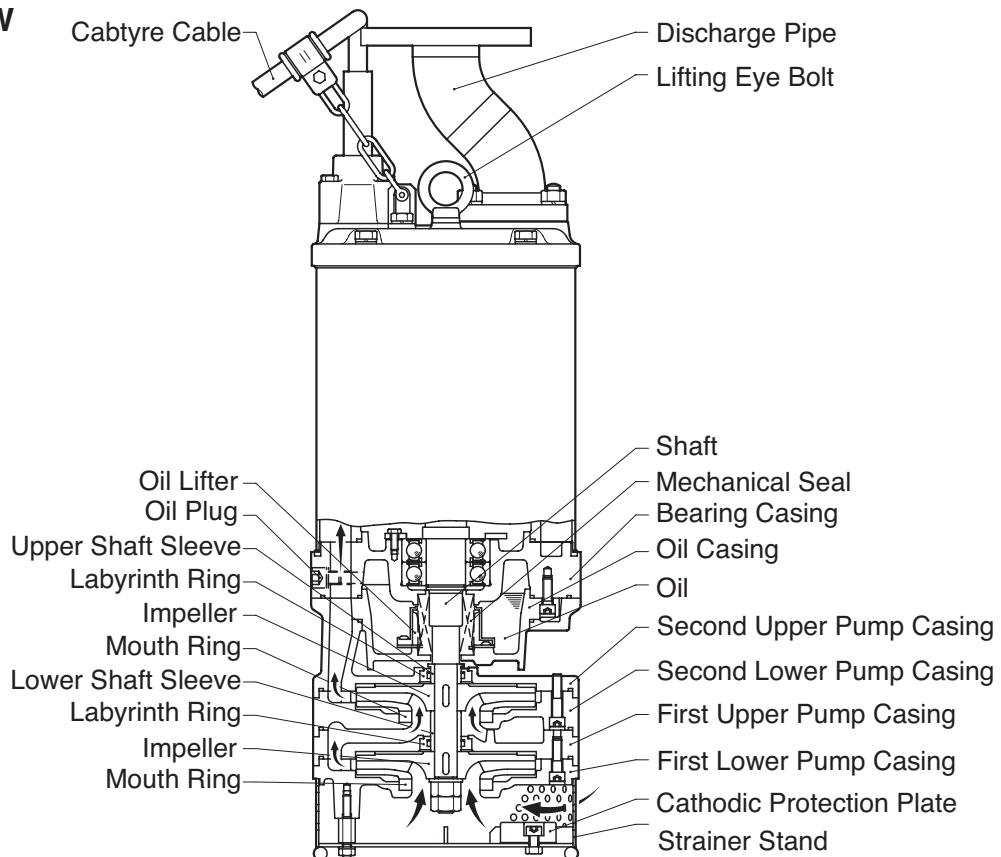

Note: *The above diagram is typical of the LH-W Series, but some models may vary slightly in appearance or internal structure.*

3 PRIOR TO OPERATION

When the pump is delivered, first perform the following checks.

Inspection

While unpacking, inspect the product for damage during shipment, and make sure all bolts and nuts are tightened properly.

Specification Check

Check the model number to make sure it is the product that was ordered. Be certain it is the correct voltage and frequency.

Example of nameplate

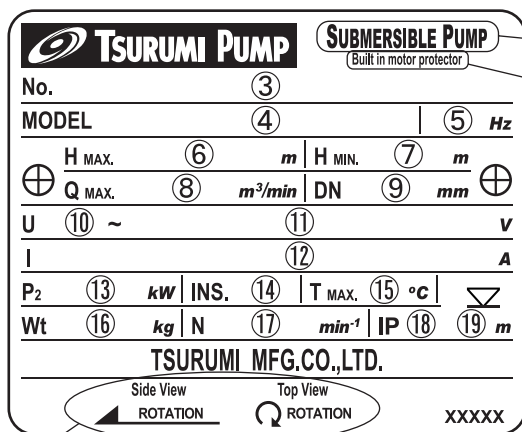

1	Submersible pump	11	Rated voltage
2	Built in motor protector	12	Rated current
3	Serial number	13	Rated output power
4	Model	14	Insulation class
5	Frequency	15	Max. liquid temperature
6	Max. total head	16	Weight without cable
7	Min. total head	17	Speed of rotation
8	Max. flow rate	18	IP degree of protection
9	Discharge bore	19	Max. immersion depth
10	Phase	20	Direction of rotation

Note: If there is any problem with the product as shipped, contact your nearest dealer or Tsurumi representative at once.

Accessory Check

Verify that all accessory items, are include in the package.

Operation Manual..... 1

Note: If you discover any damage or discrepancy in the product, please contact the dealer where this equipment was purchased or the Tsurumi sales office in your area.

Product Specifications

CAUTION Do not operate this product under any conditions other than those for which it is specified. Failure to observe this precaution can lead to electrical shock, electrical leakage, fire, water leakage or other problems.

Major Standard Specifications

Applicable Liquids	Property	Rain Water, Ground Water, Sand laden Water, 0 ~ 40°C
Pump	Impeller	Close-Type (3.7~110kW), Open-Type (3kW)
	Shaft Seal	Double Mechanical Seal
	Bearing	Shielded Ball Bearing
Motor	Specifications	Dry type Submersible Induction Motor, 2-Pole
	Insulation	Class B (3.7~22kW), Class F (3, 30~110kW)
	Protection System (Built-in)	Circle Thermal Protector (3~22kW) Miniature Protector (30kW and above)
	Leak Sensor (Built-in)	Electrode (LH Series, 55kW and above)
	Lubricant	Turbine Oil VG32
Connection to Piping		JIS 10K Flange, JIS 20K Flange

■ Standard specifications (50/60Hz)

Model	Bore mm	Phase	Starting Method	Output kW	Max.HEAD m (feet)	Max.CAPACITY m ³ /min(GPM)	Weight kg
LH33.0	80	3	Direct-on-Line	3	18/22 (59/72)	1.0/1.1 (264/290)	42
LH23.7	50	3	Direct-on-Line	3.7	36 (118)	0.52/0.45 (137/119)	87
LH35.5	80	3	Direct-on-Line	5.5	38/40 (125/131)	1.05 (277)	89
LH47.5	100	3	Direct-on-Line	7.5	41/40 (135/131)	1.52/1.5 (402/396)	130
LH411	100	3	Direct-on-Line	11	47/51 (154/167)	1.7 (449)	137
LH615	150	3	Direct-on-Line	15	52/53 (171/174)	2.4 (634)	213
LH619	150	3	Direct-on-Line	19	42/47 (138/154)	4.3/3.7 (1136/977)	350
LH422	100	3	Direct-on-Line	22	66/70.5 (217/231)	2.4/2.25 (634/594)	350
LH622	150	3	Direct-on-Line	22	54/52 (177/171)	3.75/3.9 (991/1030)	360
LH430	100	3	Star Delta	30	80/85 (262/279)	2.3 (608)	355
LH637	150	3	Star Delta	37	89.5 (294)	2.38/2.45 (629/647)	495
LH837	200	3	Star Delta	37	51.8/52 (170/171)	5.4/5.35 (1420/1413)	495
LH645	150	3	Star Delta	45	90 (295)	2.95 (779)	510
LH845	200	3	Star Delta	45	51/54 (167/177)	5.45/5.25 (1440/1387)	510
LH855	200	3	Star Delta	55	70/72 (230/236)	5.7 (1506)	820
LH675	150	3	Star Delta	75	132 (433)	2.45 (647)	865
LH875	200	3	Star Delta	75	70 (230)	6.5 (1717)	865
LH690	150	3	Star Delta	90	150 (492)	2.5 (660)	1100
LH890	200	3	Star Delta	90	90 (295)	6.0 (1585)	1150
LH6110	150	3	Star Delta	110	177/184 (581/604)	3.0/2.7 (793/713)	1200
LH8110	200	3	Star Delta	110	107/114 (351/374)	6.5 (1717)	1250
LH23.0W	50	3	Direct-on-Line	3	39/43 (128/141)	0.6/0.55 (158/145)	46
LH25.5W	50	3	Direct-on-Line	5.5	65 (213)	0.49 (129)	80
LH311W	80	3	Direct-on-Line	11	81 (266)	0.70/0.76 (185/201)	130
LH322W	80	3	Direct-on-Line	22	102/108 (335/354)	0.94/0.91 (248/240)	304
LH430W	100	3	Star Delta	30	123/127 (404/417)	1.23/1.22 (325/322)	324

Note: The weight (mass) given above is the operating weight of the pump itself, not including the cable.

4 INSTALLATION

- CAUTION**
- Do not use this pump in liquids other than water, such as oil, salt water, or organic solvents.
 - Use with a power supply voltage variation within $\pm 10\%$ of the rated voltage.
 - Do not use in water temperatures outside the range of 0 ~ 40°C, which can lead to failure, electrical leakage or shock.
 - Do not use in the vicinity of explosive or flammable materials.
 - Use only in fully assembled state.

Note: Consult your local dealer or Tsurumi representative before using with any liquids other than those indicated in this document.

Maximum allowable water pressure

CAUTION Do not use at greater than the water pressure shown in the table.

Model	Flange Specification	Maximum water pressure	Model	Flange Specification	Maximum water pressure	Model	Flange Specification	Maximum water pressure		
LH23.7	JIS10K	0.5MPa(5kgf/cm ²)	LH637	JIS10K	0.5MPa(5kgf/cm ²)	LH890	JIS10K	0.5MPa(5kgf/cm ²)		
LH35.5			LH645			LH8110				
LH47.5			LH675	LH25.5W						
LH411			JIS20K	0.5MPa(5kgf/cm ²)	LH311W	JIS20K	0.5MPa(5kgf/cm ²)			
LH422					LH6110					
LH430			JIS10K	0.5MPa(5kgf/cm ²)	LH837	JIS10K	0.5MPa(5kgf/cm ²)	LH322W	JIS10K	0.5MPa(5kgf/cm ²) -discharge pressure during use
LH615					LH845			LH23.0W		
LH619					LH855	LH33.0				
LH622					LH875					

Preparing for installation

Before installing the pump at a work site, you will need to have the following tools and instruments ready:

- Insulation resistance tester
- AC voltmeter
- AC ammeter (clamp-on type)
- Bolt and nut tighteners
- Power supply connection tools (screwdriver or box wrench)

Note: *Please read also the instructions that come with each of the test instruments.*

Checks to make before installation

Use the megohmmeter to measure the motor insulation resistance between the cabtyre cable plug tips and ground.

Note: *The reference insulation resistance (20MΩ or greater) is the value when the pump is new or has been repaired. For the reference value after installation, see below at Maintenance and Inspection (p. 12).*

Precautions in installation

WARNING When installing the pump, pay close attention to its center of gravity and weight. If it is not lowered into place correctly, it may fall and be damaged or cause injury.

CAUTION Do not under any circumstances install or move the pump by suspending it from the cabtyre cable. The cable may be damaged, causing electrical leakage, shock, or fire.

- (1) Avoid dropping the pump or other strong impact. Lift the pump by attaching a rope or chain to the eye bolts.

Note: *On cabtyre cable handling, see below at Electrical Wiring (p. 8)*

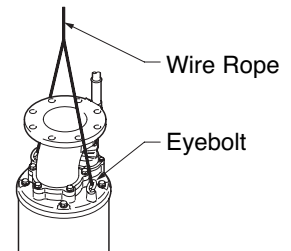

CAUTION Avoid dry operation, which will not only lower performance but can cause the pump to malfunction, leading to electrical leakage and shock.

CAUTION When the pump is installed at a work site, make sure the hose is connected in such a way as to ensure proper drainage. Otherwise water may leak out and cause damage to surrounding walls or flooring, or to equipment.

- (2) Install the pump in a location with sufficient water level, where water collects readily.

CAUTION Using a pump with insufficient head or operating with a clogged strainer stand can cause excessive vibration and noise, which may result in damage to the pump, electrical leakage and shock.

Note: *See below, "Operating water level" (p. 11) for the water level necessary for operation.*

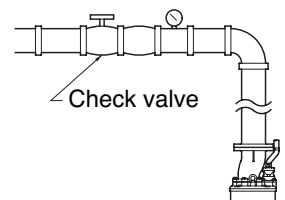
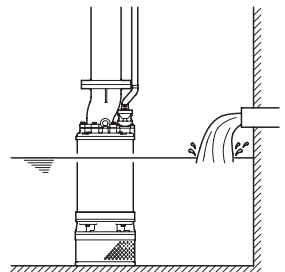

- (3) Run the piping as straight as possible, and avoid having the piping load applied directly to the pump.
- (4) The piping should be able to withstand the recoil when the pump is started up.
- (5) On the flange specification and water depth pressure resistance, see the chart on maximum allowable water pressure.
- (6) If the actual pump head (vertical life) is high, install a check valve along the piping path.

- (7) Install the piping in such a way that it can be dismantled readily from outside.
- (8) Arrange the piping so that air will not collect in it.
- (9) When performing pipe construction, make sure welding sparks or paint do not contact the pump.

Note: *This pump is supplied without piping. Use it with suitable piping material. The tip of the hose (discharge end) should be located higher than the water surface. If the end of the hose is submerged, water may flow back to the pump when the pump is stopped; and if the hose end is lower than the water surface, water may overflow when the pump is turned off.*

- (10) Use the pump in the upright position and on a flat surface. To prevent the pump from becoming submerged in mud, mount it on a block or other firm base if necessary.

The pump is stopped

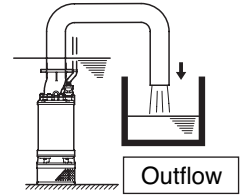
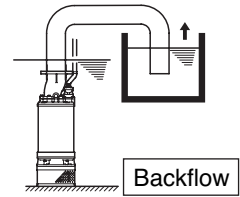

5 ELECTRICAL WIRING

Performing electrical wiring

- WARNING**
- Electrical wiring should be performed by a qualified person in accord with all applicable local regulations. Failure to observe this precaution not only risks breaking the law but is extremely dangerous.
 - Incorrect wiring can lead to electrical leakage, electrical shock or fire.
 - Always make sure the pump is equipped with the specified overload protectors and fuses or breakers, so as to prevent electrical shock from an electrical leak or pump malfunction.

Operate well within the capacity of the power supply and wiring.

Grounding

- WARNING** Do not use the pump without first grounding it properly. Failure to ground it can lead to electrical shock from an electrical leak or pump malfunction.

- CAUTION** Do not attach the grounding wire to a gas pipe, water pipe, lightning arrestor or telephone grounding wire. Improper grounding can result in electrical shock.

Cabtyre cable

- CAUTION**
- If it is necessary to extend the cabtyre cable, use a core size equal to or larger than the original. This is necessary not only for avoiding a performance drop, but to prevent cable overheating which can result in fire, electrical leakage or electrical shock.
 - If a cable with cut insulation or other damage is submerged in the water, there is a danger of water seeping into the motor causing a short. This may result in damage to the pump, electrical leakage, electrical shock, or fire.
 - Be careful not to let the cabtyre cable be cut or become twisted. This may result in damage to the pump, electrical leakage, electrical shock, or fire.
 - If it is necessary to submerge the connection leads of the cabtyre cable in water, first seal the leads completely in a molded protective sleeve, to prevent electrical leakage, electrical shock, or fire.

Do not allow the cabtyre cable leads to become wet.

Make sure the cable does not become excessively bent or twisted, and does not rub against a structure in a way that might damage it.

Connecting the cabtyre cable

WARNING Before connecting leads to the terminals, make certain the power supply is turned off (circuit breaker, etc.), to avoid electrical shock, shorting, or unexpected starting of the pump, leading to injury.

CAUTION Do not use the pump if the cabtyre cable is worn or damaged, which can result in electric shock, shorting, or fire.

Connect the leads of cabtyre cable to the control panel terminals as shown in the diagram, being careful not to let the leads become twisted together.

Direct on line

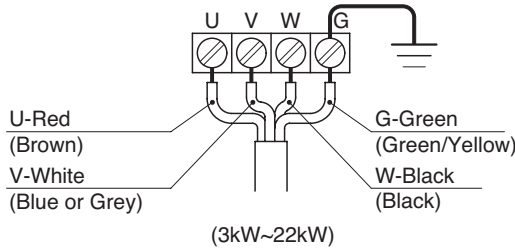

Star-delta start

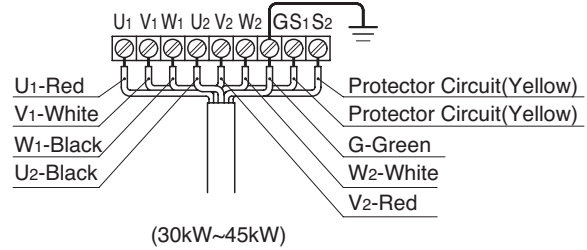

Star-delta start

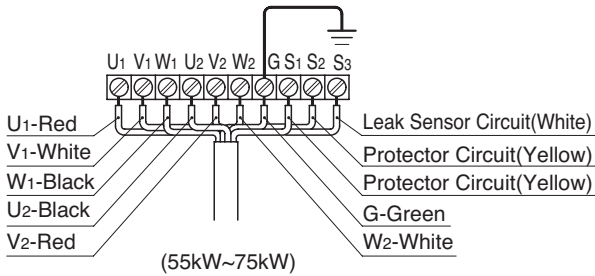

Star-delta start

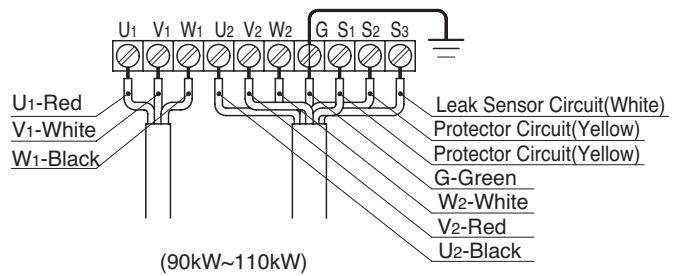

Electrical circuit diagrams

Direct on line

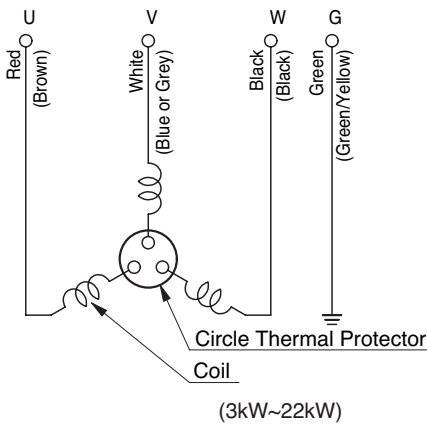

Star-delta start

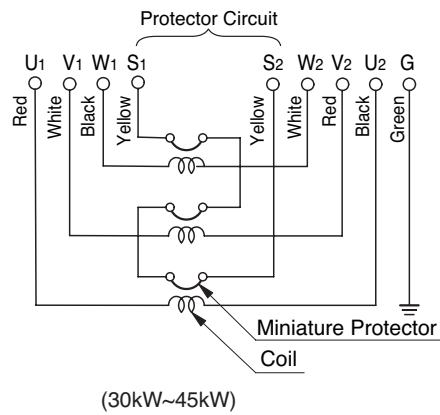

Star-delta start

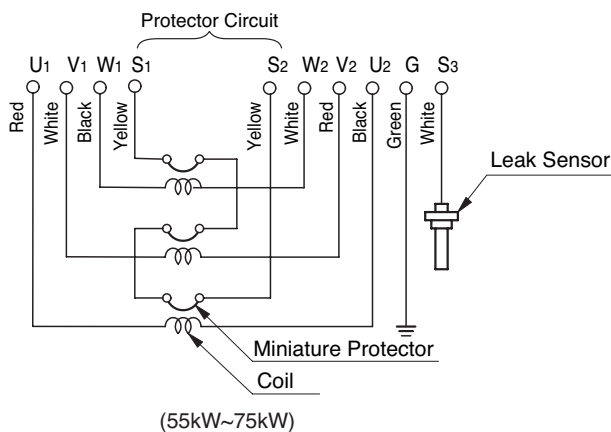

Star-delta start

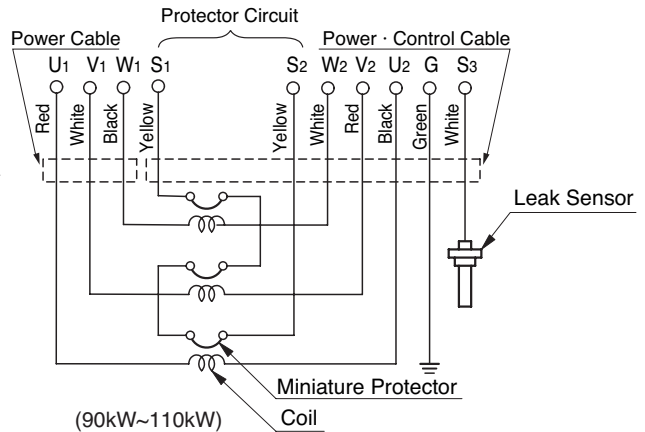

6 OPERATION

Before starting

- (1) Make sure once again that the product is of the correct voltage and frequency rating.

CAUTION Using the product at other than rated voltage and frequency will not only lower its performance but may damage the product.

Note: Confirm the rated voltage and frequency on the model name plate.

- (2) Confirm the wiring, supply voltage, circuit breaker capacity, and motor insulation resistance.

Reference insulation resistance = 20 MΩ or greater

Note: The reference insulation resistance (20MΩ or greater) is the value when the pump is new or has been repaired. For the reference value after installation, see below at Maintenance and Inspection (p.12)

- (3) The setting on the circuit breaker or other overload protector should be made in accord with the rated currency of the pump.

Note: See the model name plate on the pump for its rated current.

- (4) When powering the pump with a generator, do not share the generator with other equipment.

Test operation

WARNING

- Never operate the pump while it is suspended in the air. The recoil may result in injury or other major accident.
- Never start the pump when people are standing next to it. An electrical leak can result in electrical shock.

- (1) Run the pump for a short time(1~2 seconds) to check the direction of rotation. The rotation is correct if the pump recoil direction is counter-clockwise.

CAUTION Always perform the rotation check in air, not while the pump is submersed. Running the pump in reverse direction while submersed may damage the pump, resulting in electrical leakage or electrical shock.

- (2) If the direction is reversed, correct it using the countermeasure shown below.

WARNING Before changing the connections to correct the rotation, be sure to turn off the power supply (circuit breaker), and make sure the impeller has stopped completely, to avoid electrical shock or shorting.

COUNTERMEASURE

(Direct-on-line start models):
Interchange connections between any two of the three leads U, V, or W.

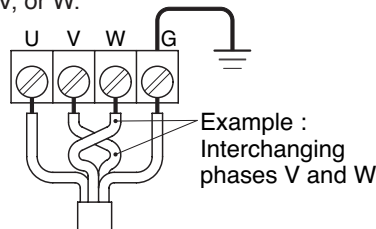

COUNTERMEASURE

(Star-delta start models):
Interchange connections between any two of the three leads R, S, or T.

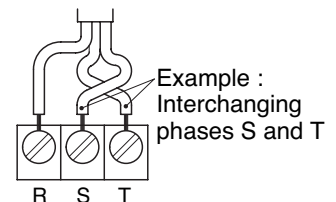

- (3) Run the pump for a short time (3~10minutes) and confirm the following.
Using an ammeter(clamp-on type), measure the operating current at the U, V, and W phase leads on the terminal strip.

COUNTERMEASURE

If the operating current exceeds the rated value, pump motor overload may be a cause. Make sure the pump has been installed under proper conditions as described in the section on Installation(p.6)

Using an AC voltmeter(tester), measure voltage at the terminal strip.

Supply voltage tolerance: within $\pm 10\%$ of rated voltage.

COUNTERMEASURE

If the supply voltage is outside the tolerance, possible causes are the power supply capacity or an inadequate extension cable. Look again at Electrical Wiring(p.7) and make sure the conditions are proper.

CAUTION In case of very excessive vibration, unusual noise or odor, turn off the power immediately and consult with your nearest dealer or Tsurumi representative. Continuing to operate the pump under abnormal conditions may result in electrical shock, fire, or electrical leakage.

(4) If the test operation turns up no problems, continue with full operation.

Operation

WARNING

- The pump may become very hot during operation. Be careful not to contact the pump accidentally to avoid being burned.
- To avoid serious injury, do not insert a finger or any other object in the pump inlet holes.
- When the pump is not used for an extended period, be sure to turn off the power (circuit breaker, etc.). Deterioration of the insulation may lead to electrical leakage, electrical shock, or fire.
- In case of a power outage, turn off the power to the pump to avoid having it start unexpectedly when the power is restored, presenting serious danger to people in the vicinity.

Pay careful attention to the water level while the pump is operating. Dry operation may cause the pump to malfunction.

Note: See below, "Operating water level" for the water level necessary for operation.

Operation water level

CAUTION Do not operate the pump below the C.W.L. (Continuous Running Water Level). Failure to observe this condition may result in damage to the pump, electrical leakage or electrical shock.

The table shows the C.W.L. for different output classes. Be careful not to allow the water level to drop below the applicable limit.

Model	C.W.L.	Model	C.W.L.	Model	C.W.L.
LH23.7	150mm	LH637	180mm	LH890	200mm
LH35.5		LH645		LH8110	
LH47.5	160mm	LH675	200mm	LH25.5W	170mm
LH411		LH690		LH311W	200mm
LH422	250mm	LH6110	180mm	LH322W	300mm
LH430		LH837		LH430W	200mm
LH615	185mm	LH845	200mm	LH23.0W	200mm
LH619	270mm	LH855		LH33.0	150mm
LH622		LH875			

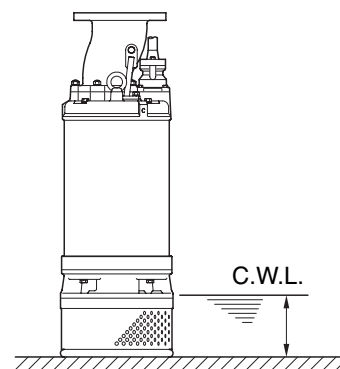

Motor protection system



WARNING During inspections or repairs, always be sure to turn off the power. Sudden unexpected starting of the pump can cause electrical shock, shorting, or serious injury.



CAUTION

- Always determine the cause of the problem and resolve it before resuming operation. Simply repeating cycles of stopping and restarting will end up damaging the pump.
- Do not continue operation at very low water level, or while the strainer stand is clogged with debris. Not only will performance suffer, but such conditions may cause noise, heavy vibration, and malfunctioning.

1. Circle Thermal Protector

If an excessive current is detected or the motor overheats, for reasons such as the following, the pump will automatically stop operating regardless of the water level, to protect the motor.

- Change in supply voltage polarity
- Overload
- Open-phase operation or operation under constraint

2. Miniature Protector

This protector is embedded inside the motor coil. If the coil should overheat for any reason, bending of the bimetal of the miniature protector triggers a signal, which in turn causes an external circuit in the starting console or control panel to shut off the motor current. When the temperature returns to normal, the protector is automatically reset, but restarting is controlled from the starting console or control panel.

Note: *A b-contact miniature protector is adopted, which is normally "closed" and goes to "open" upon overheating. To protect the motor from current surges, be sure to install a motor breaker, thermal relay or similar device in the external starting console or control panel. A 3E relay is able to protect the motor from overload, open-phase or reverse-phase operation.*

3. Water Leak Sensor

Pump models with output of 55kW or greater have a water leak sensor electrode in the oil compartment. If water leaks into the oil compartment, the electrode signal is detected by an amplifier (floatless switch), triggering the shutoff of the motor current at the external starting console or control panel. If this detector should operate, the pump will need to undergo internal repairs.

Note: *Use a floatless switch as the signal amplifier. To prevent the protector from operating due to an induced current, the external starting console or control panel should be configured to switch off the motor only after the leak sensor signal continues for several seconds.*

7 MAINTENANCE AND INSPECTION

Regular maintenance and inspections are a necessity for continued efficient functioning of the pump. If any abnormal conditions are noticed, refer to the section on Troubleshooting (p.19) and take corrective measures immediately. It is recommended that a spare pump be kept ready in case of any problems.

Prior to inspection



WARNING Detach the cabtyre cable from the receptacle or terminals, after making certain the power supply (circuit breaker, etc.) is turned off. Failure to follow this precaution may result in a serious accident from electrical shock or unexpected starting of the pump motor.

(1) Washing the pump

Remove accumulated matter from the surface of the pump and wash it with clean water. Take special care to remove any debris from the impeller.

(2) Inspecting the pump exterior

Look for any peeling or chipped paint, and make sure the nuts and bolts are fastened tightly. Any cracks in the surface should be repaired by cleaning that area, drying it and then applying a touchup coating.

Note: *Touchup is not supplied. Note that some kinds of damage or looseness may require that the unit be disassembled for repairs. Please consult with your nearest dealer or Tsurumi representative.*

Regular Inspection

Interval	Inspection Item
EveryDay	<ul style="list-style-type: none"> ■ Measure operating current ● To be below the rated current. ■ Measure power voltage ● Power supply voltage variation (within $\pm 10\%$ of the rated voltage)
Monthly	<ul style="list-style-type: none"> ■ Measure insulation resistance ● Reference insulation resistance = $1M\Omega$ or greater <i>Note: If the insulation resistance has become notably lower than the previous inspection, an inspection of the motor will be necessary.</i> ■ Pump inspection ● A noticeable drop in performance may indicate wear in the impeller, etc., or else clogging of the strainer stand, etc. Remove the clogged debris, and replace any worn parts.
Semi-yearly	<ul style="list-style-type: none"> ■ Inspection of lifting chain or rope ● Replace if damage, corrosion, or wear has occurred to the chain or the rope. Remove if foreign object is attaching to it. ■ Oil inspection ● Check the oil every 6 months or after 3,000 hours of use, whichever comes first. <i>Note: Refer to details of oil inspection and oil change (p.13)</i>
Yearly	<ul style="list-style-type: none"> ■ Change oil ● Change the oil every 12 months or after 6,000 hours of use, whichever comes first. <i>Note: Refer to details of oil inspection and oil change (p.13)</i> ■ Change mechanical seal <i>Note: Specialized know-how is required for inspecting and replacing the mechanical seal. Consult with your nearest dealer or Tsurumi representative.</i>
Every 2 to 5 years	<ul style="list-style-type: none"> ■ Overhaul ● This should be carried out even if there are no problems with the pump. The frequency depends on how continuously the pump is in use. <i>Note: Consult with your nearest dealer or Tsurumi representative regarding overhauls.</i>

Storage

When the pump is out of use for an extended period, wash it and dry it thoroughly, then store it indoors.

Note: Always run a test operation before putting the pump back into service.

When the pump is left installed in water, it should be run at regular intervals (about once a week).

Oil inspection and Oil change



WARNING When the pump is tilted for inspecting or changing the oil, pay careful attention to the center of gravity and weight of the pump. When lowering the pump, fasten the chain or rope to the eyebolts provided for this purpose. Failing to lower the pump completely may result in damage or injury if the pump is dropped.

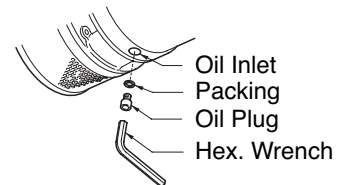

Inspecting Oil

Remove the oil plug and tilt the pump to drain a small amount of oil. If the oil is milky white or has water mixed in with it, the mechanical seal may be faulty. In this case the pump will need to be disassembled and repaired.

Model	Oil Quantity	Model	Oil Quantity	Model	Oil Quantity
LH23.7	1,650ml	LH637	4,800ml	LH890	8,000ml
LH35.5		LH645			
LH47.5	2,500ml	LH675	6,100ml	LH25.5W	720ml
LH411		LH690			
LH422	6,900ml	LH6110	8,000ml	LH311W	800ml
LH430		LH837			
LH615	3,740ml	LH845	4,800ml	LH322W	2,350ml
LH619	6,900ml	LH855	6,100ml	LH430W	
LH622		LH875		LH23.0W	380ml
				LH33.0	

The oil quantity of LH675/855/875-50/60 will be 6,500ml.

Replacing Oil

Remove the oil plug and drain all the oil, then replace it with the specified amount.

Note: Worn oil and other waste products should be disposed of by a qualified agent, in accord with applicable local laws. The oil plug packing and O-ring should be replaced each time the oil is inspected or changed.

Refilling bearing grease

Models with output 55kW or greater require that bearing grease be refilled periodically. With the pump standing upright, supply grease at the grease nipple on the bearing housing side of lower bearing (PT1/8 for 55~75 kW models, M12 screw for 90~110kW models), and at the grease nipple at the upper part of the motor for models with an upper bearing (90~110kW ,PT1/4). The table shows the different bearing types, specified amount of grease, initial supply of grease, and refill frequency.

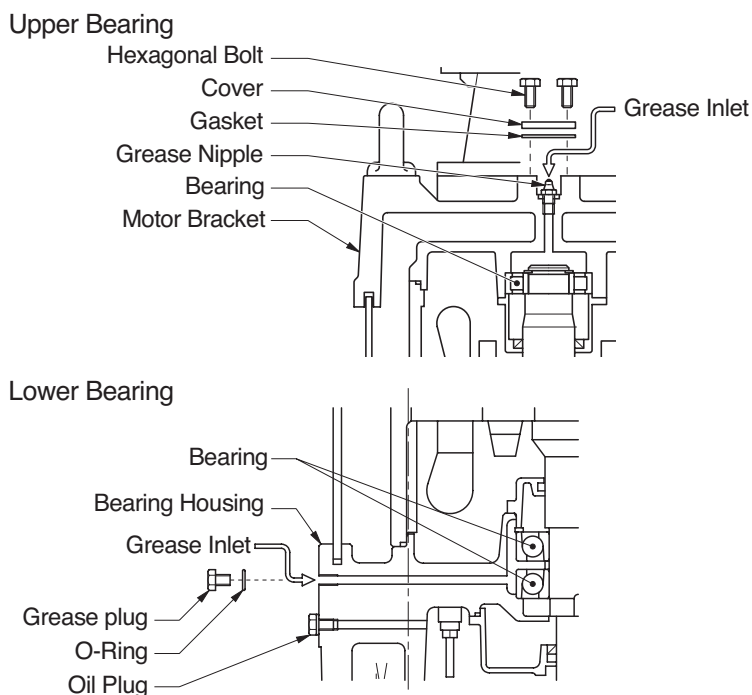

Note: Greasing generally is good for around 3,000 hours of use, but this can vary depending on the use conditions.

Model	Grease Type	Initial Amount	Refill Amount
LH855 LH675 LH875	“ENS GREASE” (Nippon Oil Co.), or equivalent ¹	360g (12.70 oz.)	60g (2.12 oz.)
LH690 LH6110 LH890 LH8110	“MULTINOC DELUX 2”(Nippon Oil Co.), or equivalent ²	Upper: 100g (3.53 oz.) Lower: 200g (7.05 oz.)	Upper: 30g (1.06 oz.) Lower: 60g (2.12 oz.)

The grease type of LH855/675/875-50/60 will be “RAREMAX SUPER”(Kyodo Yushi Co.Ltd), “LGHP 2”(SKF). The initial amount will be 100g (3.53 oz.). The refill amount will be 50g (1.76 oz.).

Item	*1	*2
Soap Type	Urea compounds	Lithium-Sodium complex
Base Oil Type	Synthetic-Ester Oil	Mineral Oil
Viscosity(40°C / 104°F)	31.5mm ² /s(cSt)	85mm ² /s(cSt)
Viscosity(100°C / 212°F)	5.8mm ² /s(cSt)	9.5mm ² /s(cSt)
Temperature Range	-40 to 175°C / -40 to 347°F	-20 to 135°C / -4 to 275°F
Dropping Point	250°C / 482°F	202°C / 396°F
Penetration NLGI grade	2	2
Penetration (60 strokes 25°C / 77°F)	267	270
Penetration (100,000 strokes 25°C / 77°F)	310	300

Replacement Parts

The table lists the parts that need to be replaced periodically. Replace these using the recommended frequency as a guideline.

Part	Recommended Frequency
Mechanical Seal	When oil in oil compartment becomes milky.
Oil (Turbine Oil VG 32)	Every 6,000 hours of 12 months, whichever comes first.
Bearing Grease	At overhaul
Packing, O-Ring	Each time pump is disassembled or inspected
Oil Seal	When the lip is worn, and each time pump is disassembled or inspected
Labyrinth Ring	When it becomes worn.
Shaft Sleeve	When it becomes worn.
Cathodic Protection Plate	When it becomes corroded.

8 DISASSEMBLY AND REASSEMBLY

WARNING

- Before disassembling the pump, first detach the cabtyre cable from the receptacle or terminals, after making certain the power supply (circuit breaker, etc.) is turned off. To avoid electrical shock, do not work with wet hands. Never check the operation of any parts (impeller rotation, etc.) by turning on the power while the unit is partially assembled. Failure to observe these precautions may result in serious accident.
- Do not disassemble or repair any parts other than those designated here. If repairs are necessary in any other than the designated parts, consult with your nearest dealer or Tsurumi representative. Improper repairs can result in electrical leakage, electrical shock, fire, or water leaks.
- After reassembly, always perform a test operation before resuming use of the pump. Improper assembly will cause the pump to malfunction, resulting in electrical shock or water leaks.

The procedure for disassembly and reassembly is shown here to the extent necessary for impeller replacement. A specialized environment and facilities are necessary for work on the mechanical seal and the motor parts. Contact your nearest dealer or Tsurumi representative in the event such repairs are necessary.

LH615 Disassembly

Note: *Before disassembly, drain the oil from the pump.
Models LH675, LH855, LH875, LH690, LH6110, LH890, and LH8110 are similar in structure.*

- (1) Remove the strainer stand.
Remove the hex. bolts and plain washers at the bottom of pump, then remove the strainer stand from the pump.
- (2) Remove the lower pump casing.
Remove the hex. bolts, spring washers, stud bolts and plain washers, then remove the lower pump casing from the pump.
- (3) Remove the impeller.
With a box spanner or other tool, remove the impeller nut, spring washer and impellar thread protect. cover, then remove the impeller and lower shaft sleeve from the shaft.
- (4) Remove the upper pump casing.
Remove the hex. nuts and spring washers to remove the upper pump casing.
- (5) The upper shaft sleeve can be removed easily once the upper pump casing is removed.
- (6) When absolutely necessary, the mechanical seal can be removed by first removing the oil casing.

Note: *See also the manual that comes with the replacement mechanical seal.*

Remove the hex. bolts and spring washers, then detach the oil casing from the pump, being careful not to damage the sliding surface of the mechanical seal. Remove the mechanical seal on the rotating end from the shaft, then remove the mechanical seal on the upper fixed end.

 **CAUTION** A worn impeller can have sharp edges; be careful to avoid injury.

Exploded View [LH615]

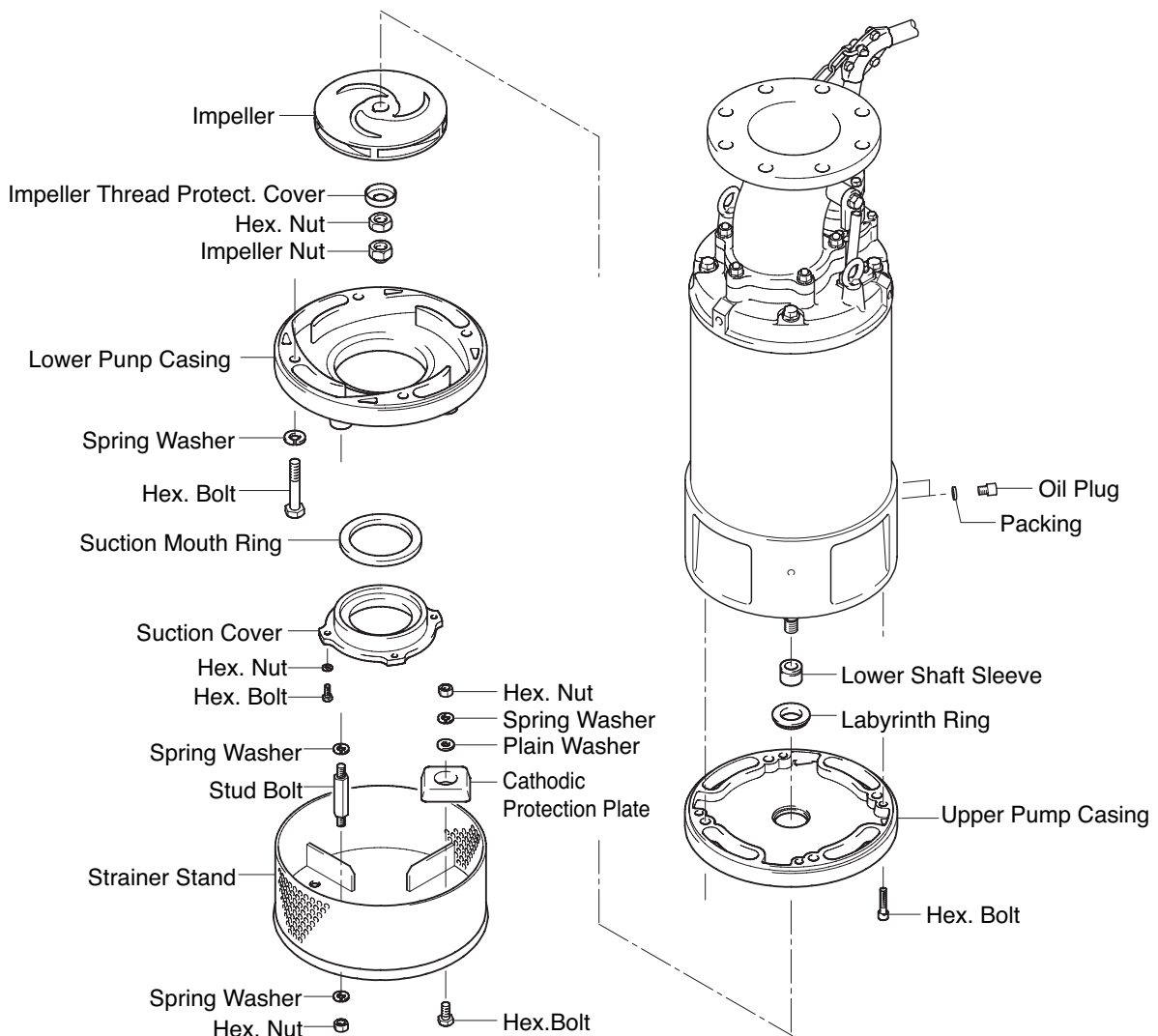

Reassembly

Reassembly can be performed by reversing the steps for disassembly.

Note: *After reassembling the pump, be sure to fill it with the required amount of oil. Replace the packing and o-ring with new parts. Replace any other worn or damaged parts as well.*

The sliding surface of the mechanical seal should be wiped clean with a non-oily cloth. For ease of insertion, oil the outer parts of the shock-absorbent rubber.

Note: *See the manual that comes with the replacement mechanical seal for further details.*

After attaching the impeller, and again after assembly is completed, check to make sure the impeller rotates smoothly and that it does not rub against the suction cover (applies to models LH675, LH855, LH875, LH690, LH6110, LH890, and LH8110).

Note: Apply liquid gasket (Three Bond TB1207B or equivalent) on the lower pump casing when assembling LH855, LH675, LH875, LH6110, or LH8110 pump.

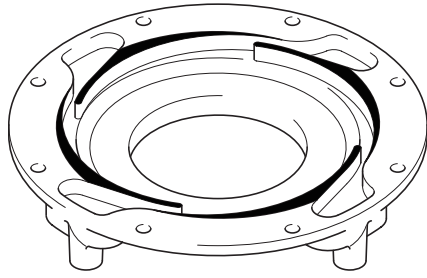

LH675

The place to be applied is the top part of the casing, where no packing shall be used. It is the part filled with black in the drawing.

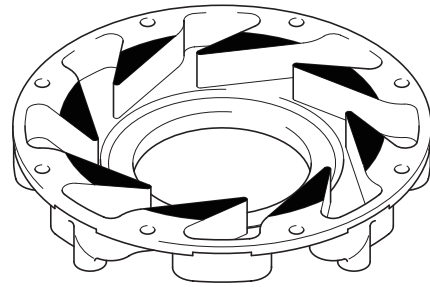

LH855/875

The place to be applied is the top part of the casing, where no packing shall be used. It is the part filled with black in the drawing.

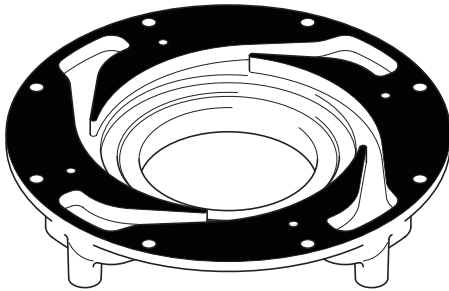

LH6110

The place to be applied is the top part of the casing. It is the part filled with black in the drawing.

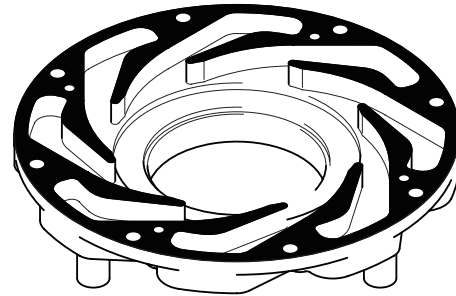

LH8110

▶ LH25.5W Disassembly

Note: Before disassembly, drain the oil from the pump.

- (1) Remove the strainer stand.
Remove the hex. bolts and spring washers at the bottom of pump, then remove the strainer stand from the pump.
- (2) Remove the 1st lower pump casing.
Remove the hex. socket bolts, then remove the 1st lower pump casing from the pump.
- (3) Remove the impeller.
Remove the hex. double nuts and plain washers, then remove impeller, impeller adjusting washer, and the lower shaft sleeve from the shaft.
- (4) Remove the 1st upper pump casing.
Remove the hex. socket bolts, then remove the 1st upper pump casing from the pump.
- (5) Remove the 2nd lower pump casing.
Remove the hex. socket bolts, then remove the 2nd lower pump casing from the pump.
- (6) Remove the impeller.
Now remove the impeller, impeller adjusting washer from the shaft.
- (7) Remove the 2nd upper pump casing.
Remove the hex. nuts and spring washer, then remove the 2nd upper pump casing from the pump and lift the upper shaft sleeve from the shaft.
- (8) When absolutely necessary, the mechanical seal can be removed by first removing the oil casing.

Note: See also the manual that comes with the replacement mechanical seal.

⚠ CAUTION A worn impeller can have sharp edges; be careful to avoid injury.

Exploded View [LH25.5W]

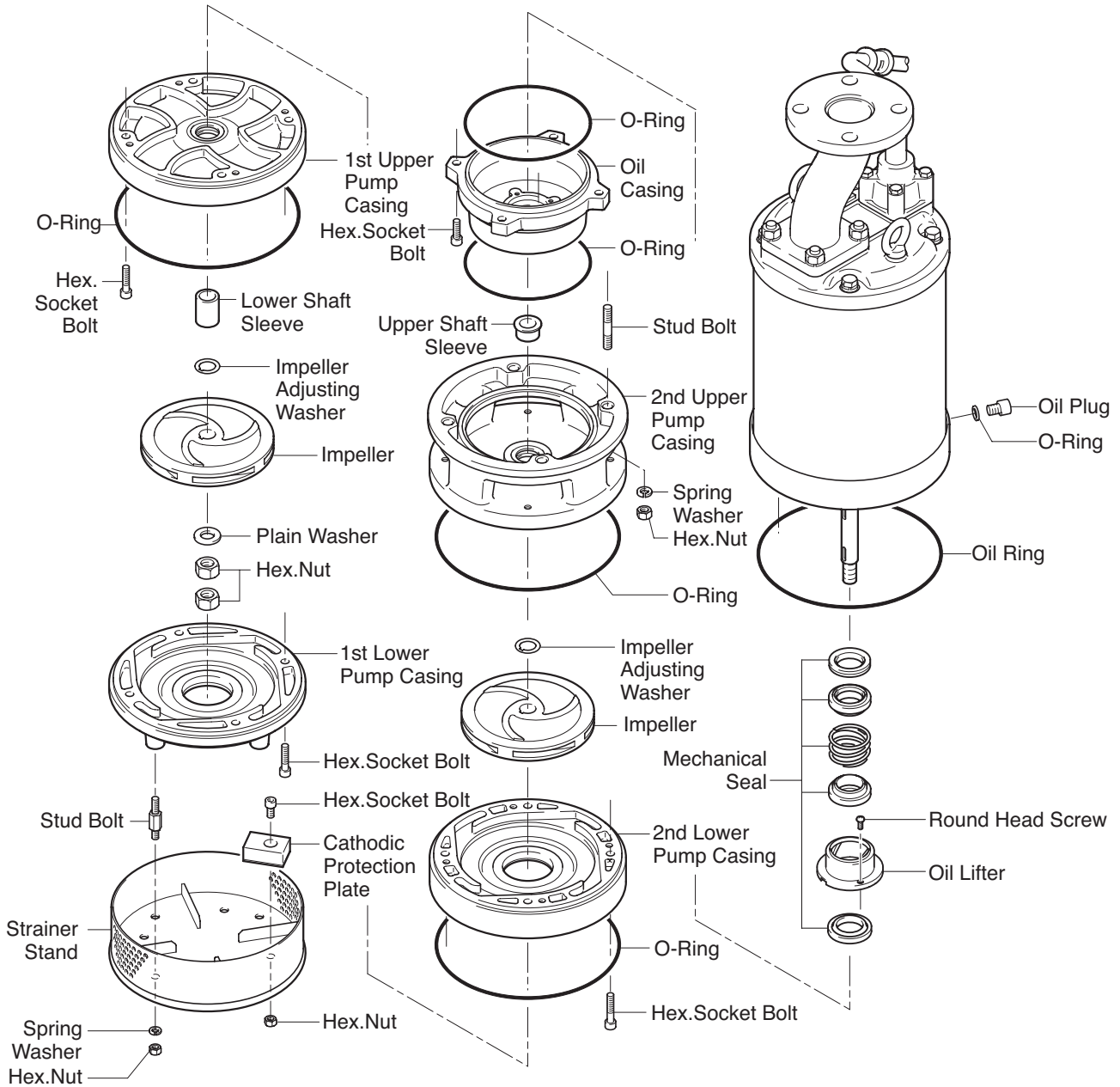

Reassembly

Reassembly can be performed by reversing the steps for disassembly.

Note: After reassembling the pump, be sure to fill it with the required amount of oil. Replace the packing and o-ring with new parts. Replace any other worn or damaged parts as well.

The sliding surface of the mechanical seal should be wiped clean with a non-oily cloth. For ease of insertion, oil the outer parts of the shock-absorbent rubber.

Note: See the manual that comes with the replacement mechanical seal for further details.

After attaching the impeller, and again after assembly is completed, check to make sure the impeller rotates smoothly and that it does not rub against the pump casing.

Note: The mouth ring is press-fit into the lower pump casing, and the labyrinth ring is press-fit into the upper pump casing; so it is necessary to replace the upper and lower pump casing together when worn.

9 TROUBLESHOOTING

⚠ WARNING Always turn off the power before inspecting the pump. Failure to observe this precaution can result in serious accident.

Before ordering repairs, carefully read through this operation manual, then repeat the inspection. If the problem remains, contact your nearest dealer or Tsurumi representative.

Problem	Possible cause	Countermeasure
Pump Will not start	<ol style="list-style-type: none"> 1) Power is off. 2) Cabtyre cable is cut or not connected properly. 3) Impeller is clogged. 	<ol style="list-style-type: none"> 1) Restore power. 2) Repair/replace the cable or fix the connection. 3) Inspect the pump and remove any debris.
Pump stops soon after starting (Motor protector operates)	<ol style="list-style-type: none"> 1) Impeller is clogged. 2) Low voltage. 3) Wrong power frequency. 4) Extended operation with a clogged strainer. 5) Faulty motor. 6) Excessive sand is discharged. 	<ol style="list-style-type: none"> 1) Remove any debris. 2) Provide the rated voltage, or make sure the cabtyre cable extension is the proper standard. 3) Check the name plate, and replace the pump. 4) Remove debris from the strainer. 5) Repair or replace the motor. 6) Place the pump on a block or other base to prevent sand from being sucked into it.
Poor lift or discharge capacity	<ol style="list-style-type: none"> 1) Worn out impeller. 2) Sharply bent or clogged hose. 3) Strainer stand clogged or buried. 4) Motor direction is reversed 	<ol style="list-style-type: none"> 1) Replace. 2) Straighten out any sharp bends. Enclose the pump with a screen to keep away debris. 3) Remove debris from the strainer stand or place a block under the pump. 4) Interchange power supply leads(p.10).
Pump generates noise or vibration	<ol style="list-style-type: none"> 1) Grease in the bearing is running out or insufficient. 2) Damaged motor bearing. 	<ol style="list-style-type: none"> 1) Add grease. 2) Contact dealer and replace motor.

Disposal Product

Properly dispose of the product by disassembling it, presorting the contents, and sending them to the waste material treatment site.

The following information is required when ordering repairs or making other inquiries.

Product model	
Manufacturing number	
Purchase date	
Remarks	